

Alumno

Examen CAD 2007

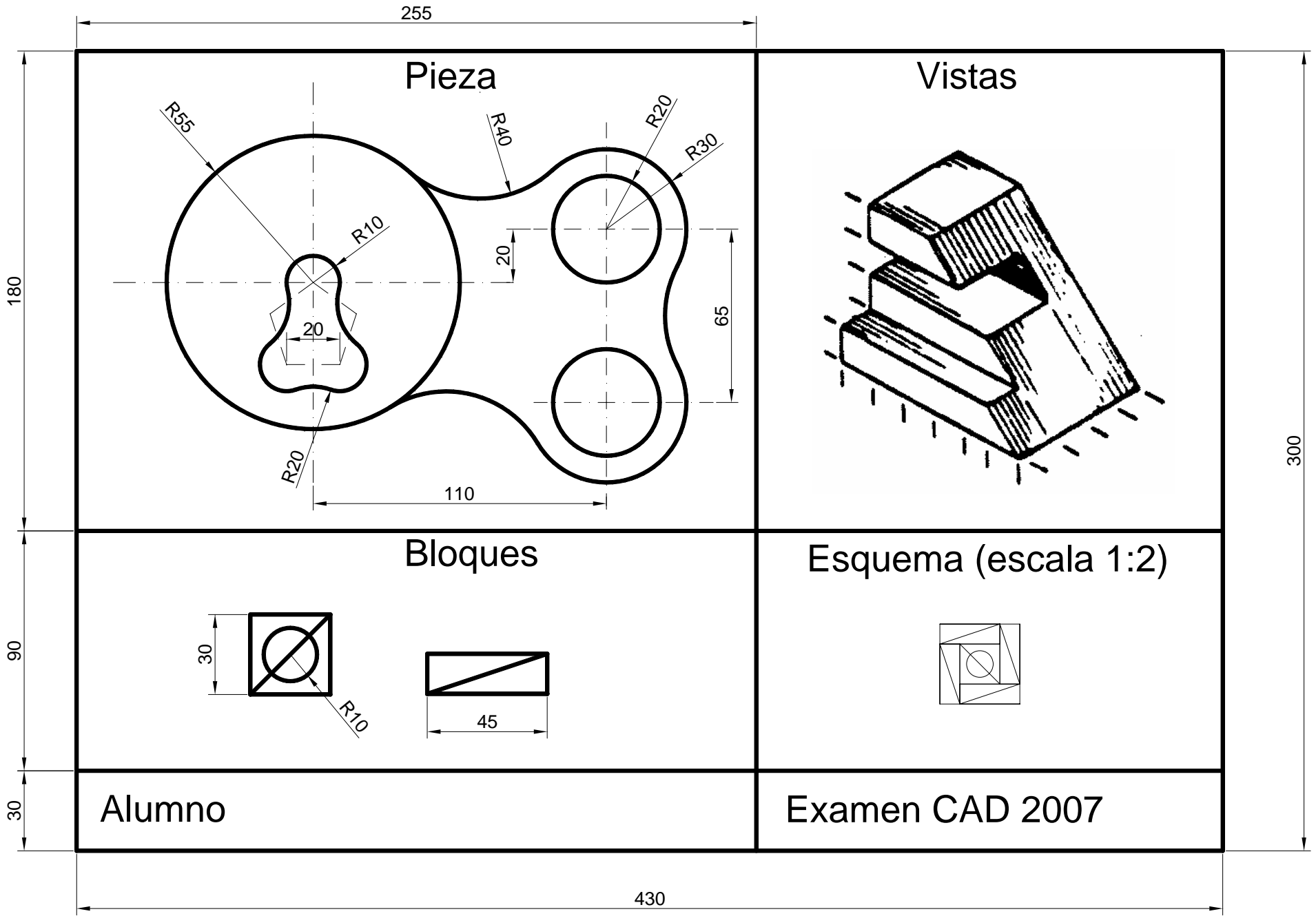

Pieza

Vistas

Bloques

Esquema (escala 1:2)

Alumno

Examen CAD 2007

255

180

20

65

110

30

45

R10

430

300

R55

R40

R20

R30

R10

R20

20

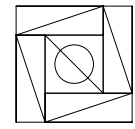
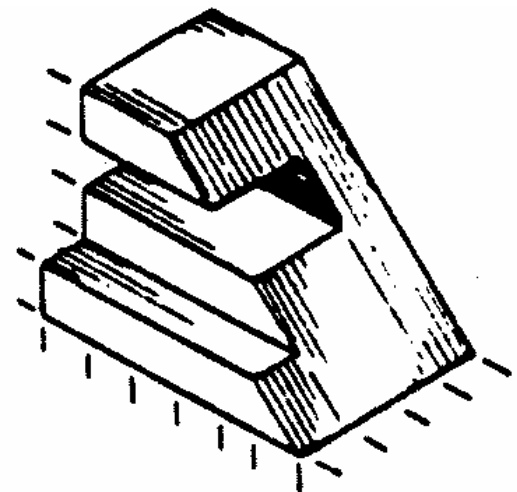

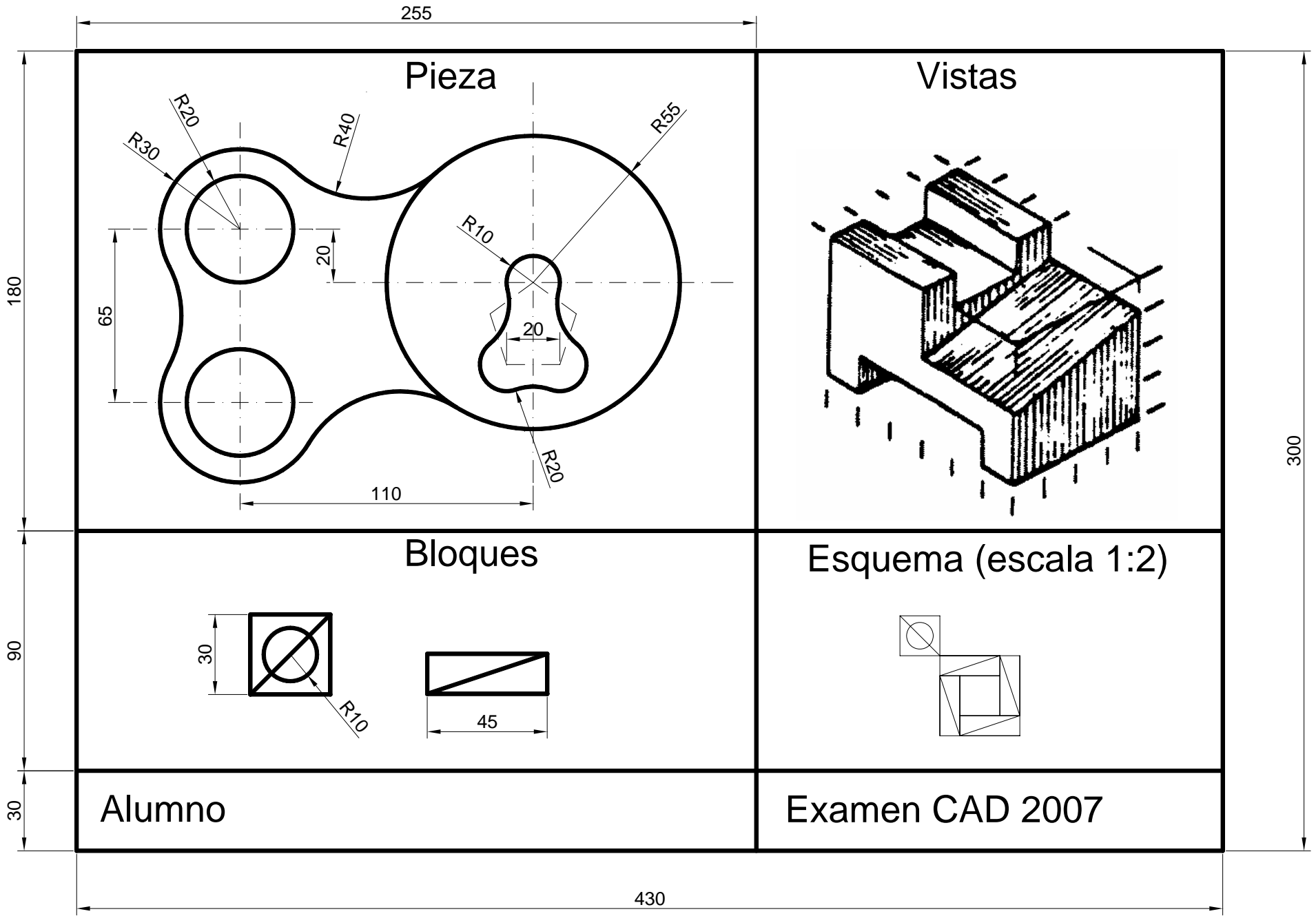

255

Pieza

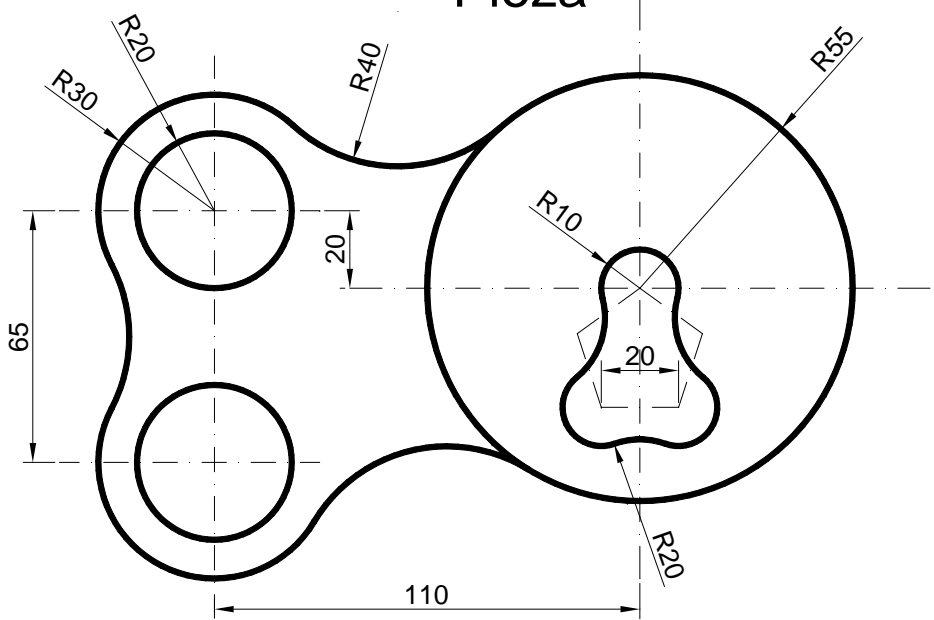

Vistas

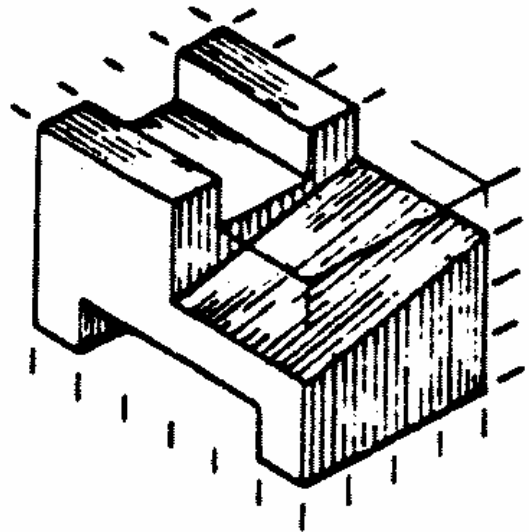

Bloques

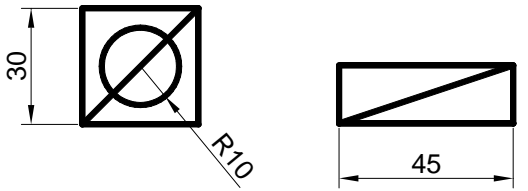

Esquema (escala 1:2)

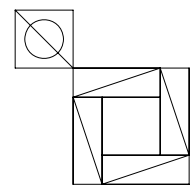

Alumno

Examen CAD 2007

430

180

90

30

300

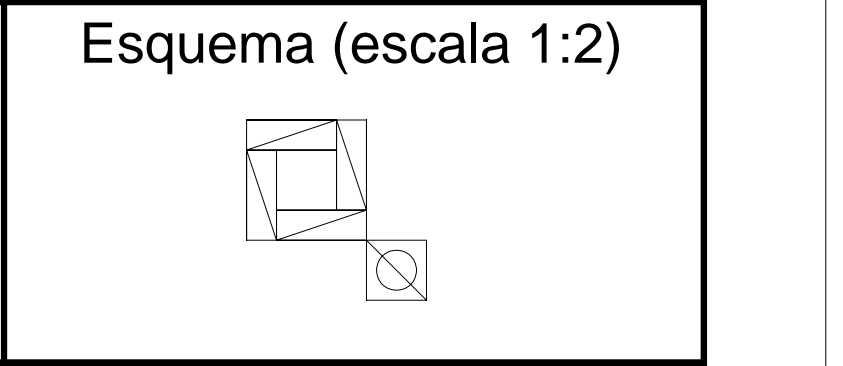
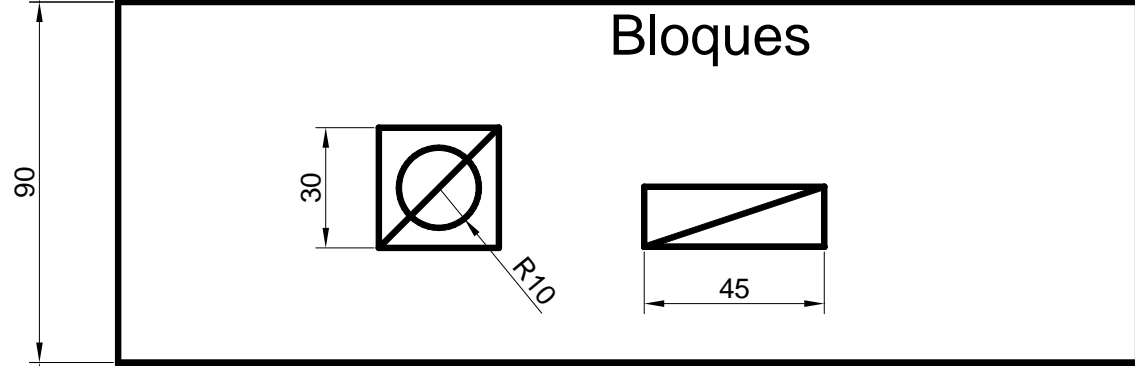
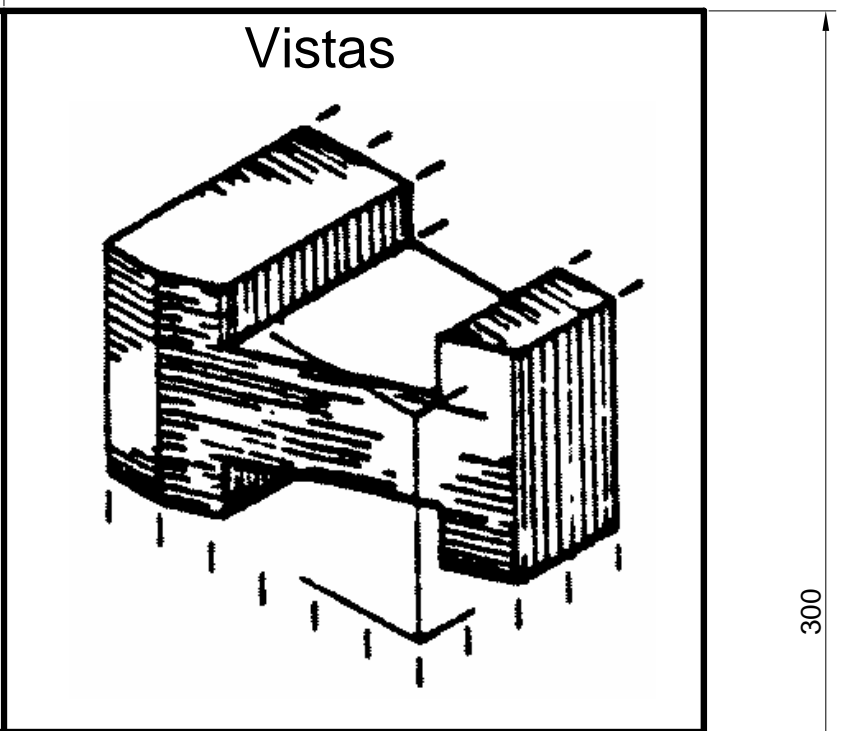
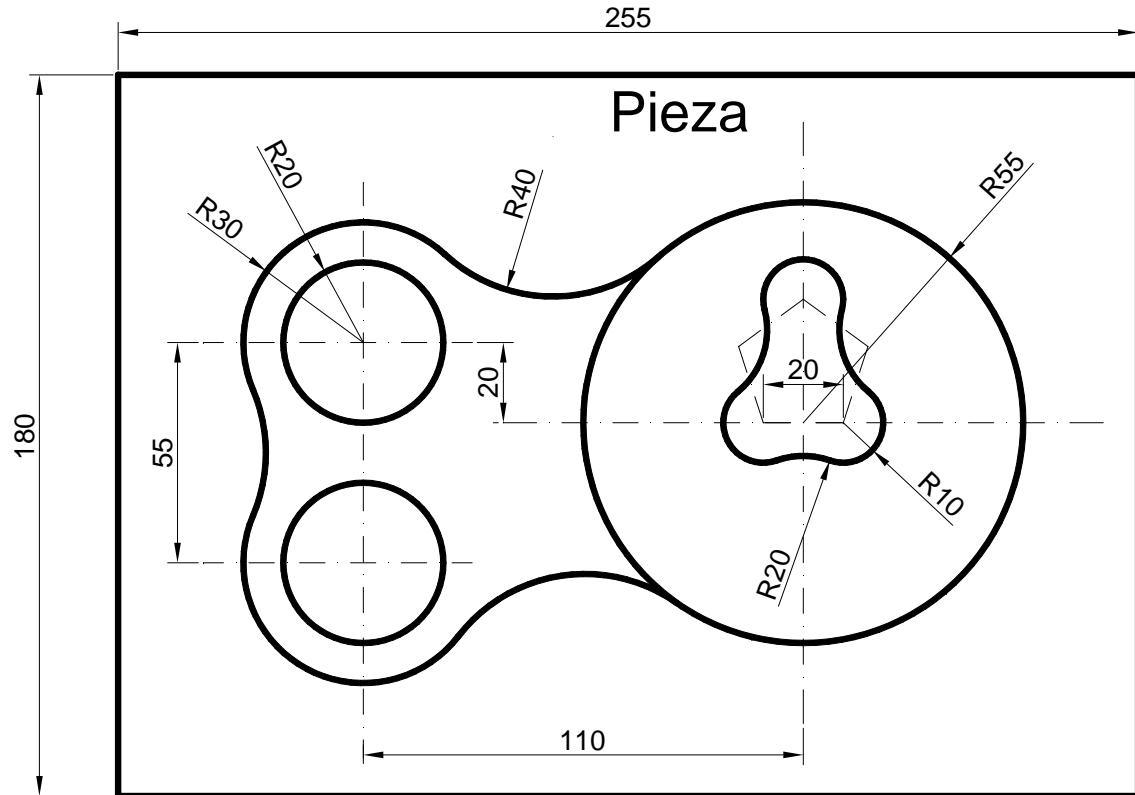

Alumno

Examen CAD 2007

430

300

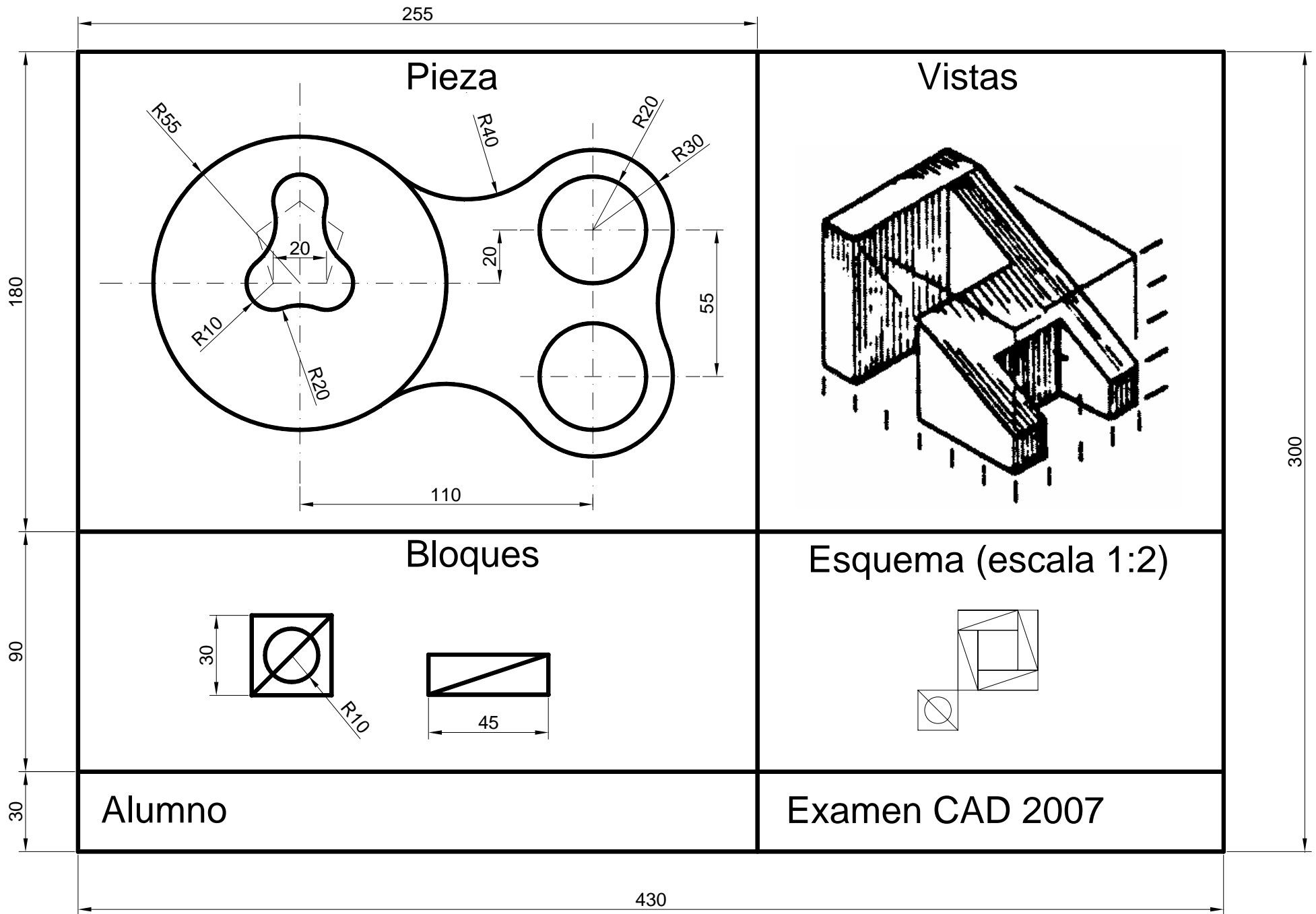

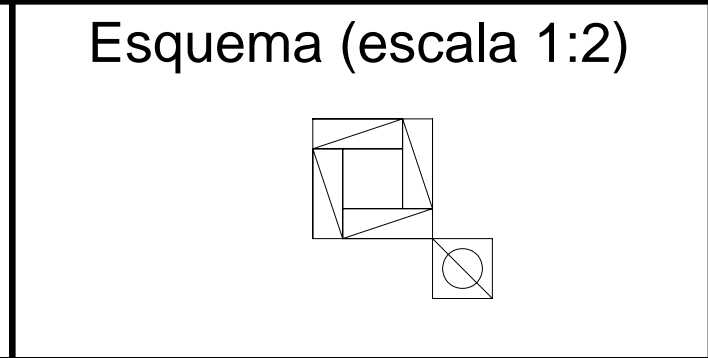
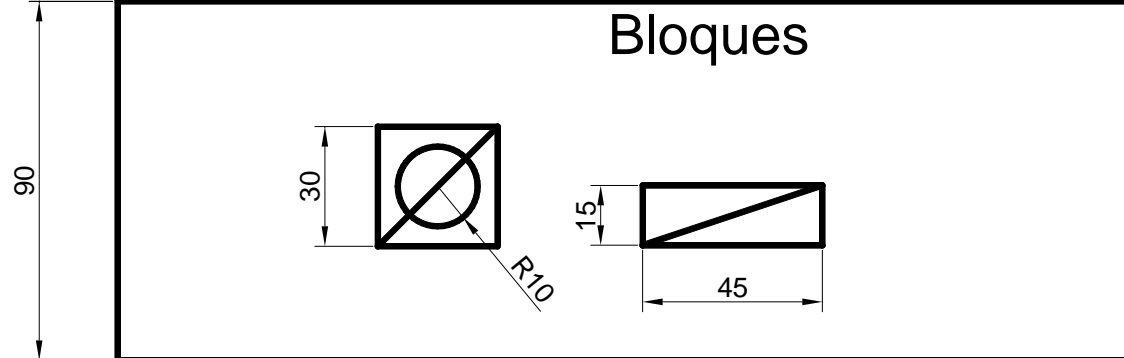
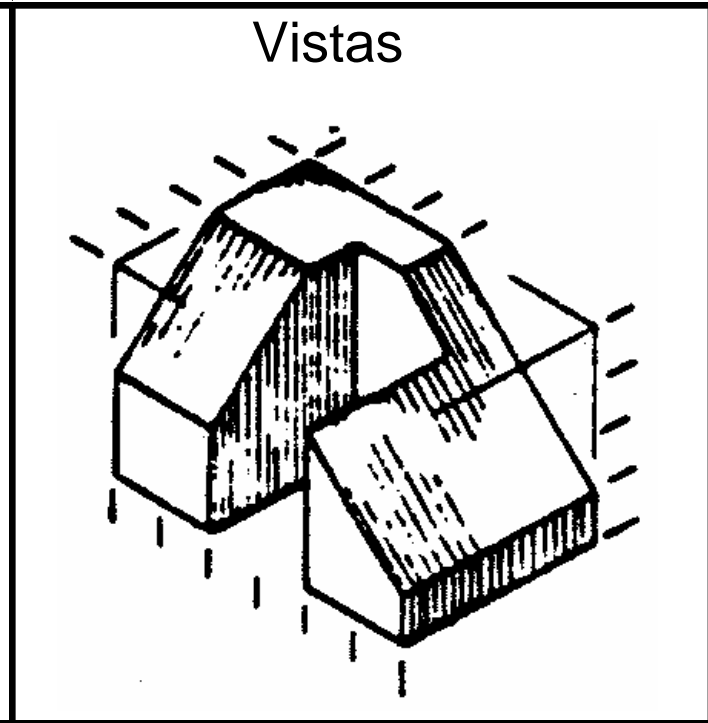
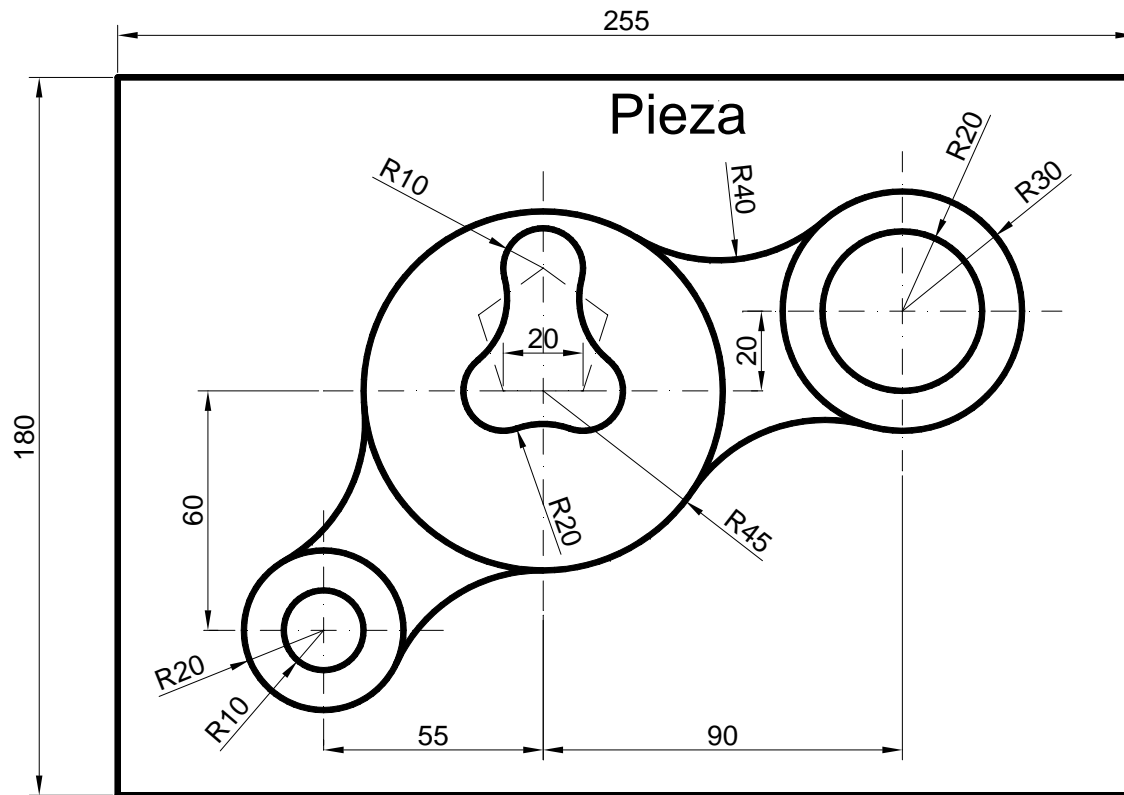

Alumno

Examen CAD 2007